

# UNI-EAP-01



- CZ – POZOR:** Práce s výrobkem INNOTECH je povolena teprve po kompletním přečtení a porozumění bezpečnostních pokynů a návodu k montáži.
- DE – ACHTUNG:** Die Verwendung des INNOTECH-Produkts ist erst zulässig, nachdem die Sicherheitshinweise und Montageanleitung vollständig gelesen und verstanden wurden.
- DK – GIV AGT:** Det er først tilladt at anvende INNOTECH-produktet, efter du har læst og forstået sikkerhedshenvisningerne og monteringsvejledningen.
- EN – ATTENTION:** Use of the INNOTECH product is permitted only after the safety instructions and instruction manual in the respective language have been read.
- ES – ATENCIÓN:** Solo se autorizará el uso del producto INNOTECH una vez que se hayan leído y entendido completamente las indicaciones de seguridad y las instrucciones de montaje.
- FR – ATTENTION :** L'utilisation du produit INNOTECH n'est autorisée qu'après avoir intégralement lu et compris les consignes de sécurité et la notice de montage.
- HU – FIGYELEM:** Az INNOTECH termék használatát csak akkor engedhető meg, ha a biztonsággi utasításokat és az összeszerelési utasításokat teljes mértékben elolvasta és megértette.
- IT – ATTENZIONE:** L'utilizzo del prodotto INNOTECH è permesso solo previa lettura completa e comprensione integrale delle avvertenze di sicurezza e le istruzioni di montaggio.
- NL – ATTENTIE:** Dit INNOTECH-product mag pas worden gebruikt nadat u de gebruikershandleiding en de montagehandleiding volledig heeft gelezen en begrepen.
- PL – UWAGA:** Używanie produktu INNOTECH jest dozwolone dopiero po zapoznaniu się z wszystkimi zasadami bezpieczeństwa i instrukcją montażu.
- PT – ATENÇÃO:** O uso do produto INNOTECH apenas é permitido depois de terem sido lidas e compreendidas na totalidade as indicações de segurança e o manual de montagem.
- SK – POZOR:** Použitie výrobku INNOTECH je povolené až vtedy, keď si úplne prečítate a pochopíte bezpečnostné pokyny a montážny návod.
- SL – POZOR:** Uporaba izdelkov INNOTECH je dovoljena šele po tem, ko preberete in so vam jasne vse varnostne opombe in navodila za montažo.
- SV – O B S :** INNOTECH-produkten får inte användas, förrän säkerhets- och monteringsinstruktionerna har lästs igenom och förstås fullständigt.
- TR – DİKKAT:** INNOTECH ürününün kullanımına ancak güvenlik uyarıları ve montaj talimatı tamamen okunup anlaşıldıktan sonra izin verilir.
- ZH – 注意:** 只有在完全阅读并理解安全提示和装配说明书之后,才允许使用INNOTECH产品。



1



2



2

3



3

4



3

5



4

6



7

7



10

8



11

2



1x



A

1x



A) UNI-EAP-01



.....

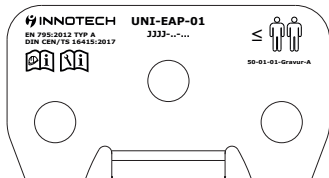

3



[mm]

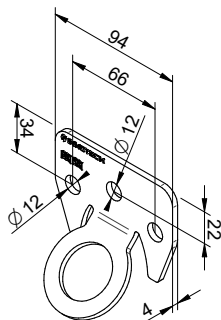

4

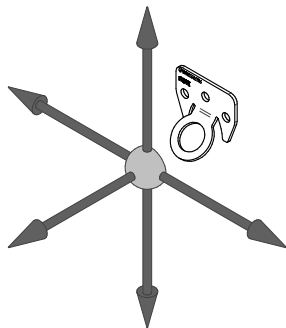

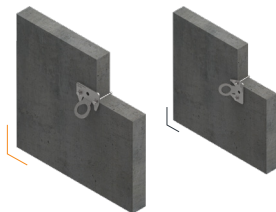
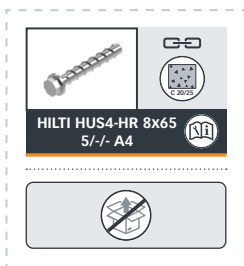

[mm]

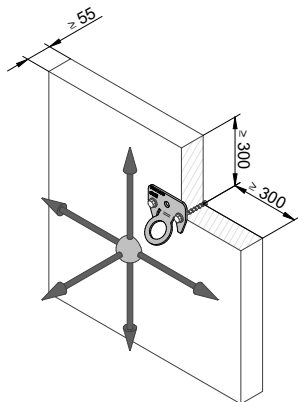
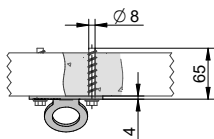

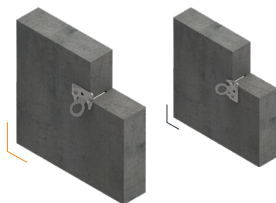
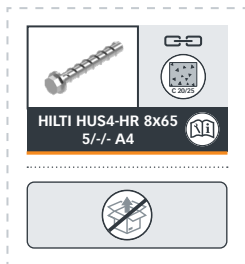

[mm]

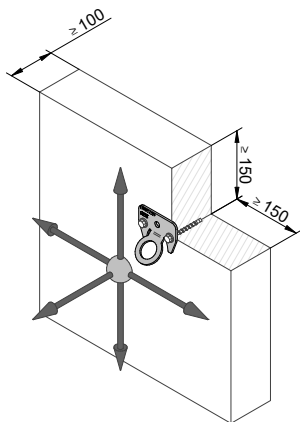
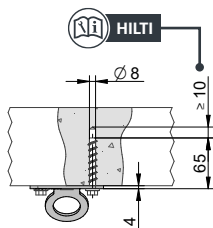

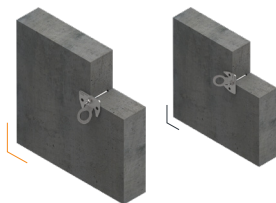

[mm]

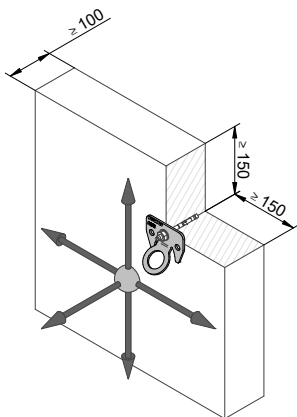
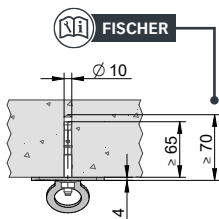

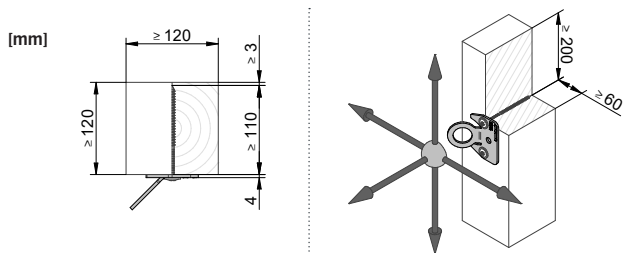
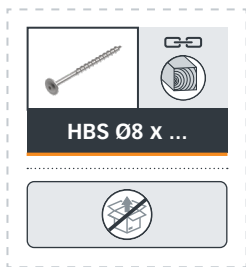
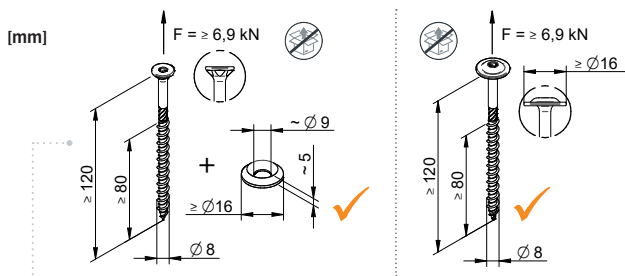

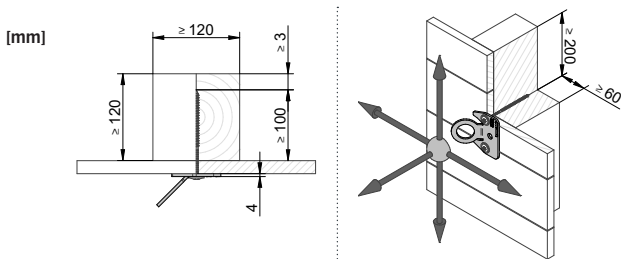
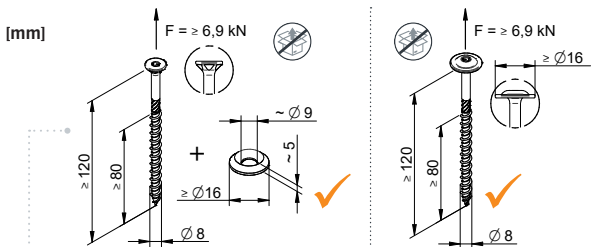





[mm]

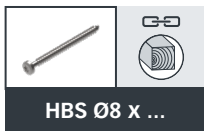
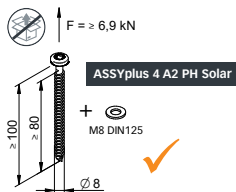
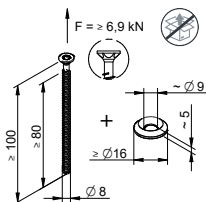

HBS Ø8 x ...

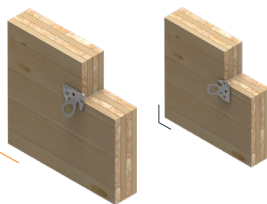

[mm]

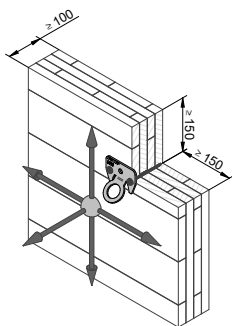
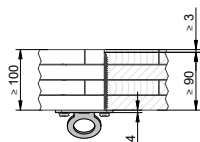

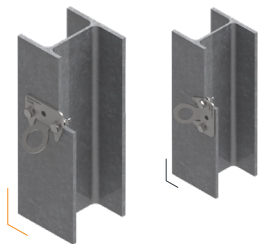
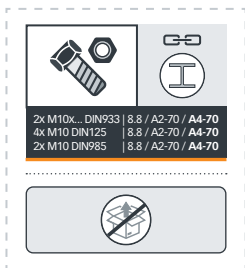

[mm]

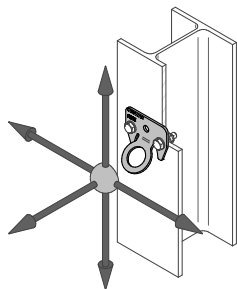
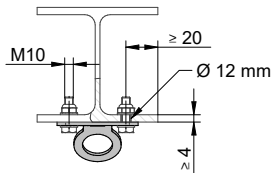

INNOTECH WEB-APP

# INNO|doc

Simple. Clear. Document.



[www.innotech.at/de/innodoc](http://www.innotech.at/de/innodoc)

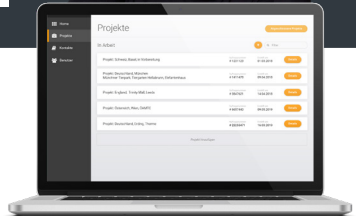

**INNOTECH Arbeitsschutz GmbH**

Laizing 10, A-4656 Kirchham

T: +43 7619 22122-0

[office@innotech.at](mailto:office@innotech.at) | [www.innotech.at](http://www.innotech.at)



UNI-EAP-01  
[www.innotech.at](http://www.innotech.at)